

PSR0601

Shaft dia. (軸徑) $\phi 6$ Lead (導程) 1mm

C5

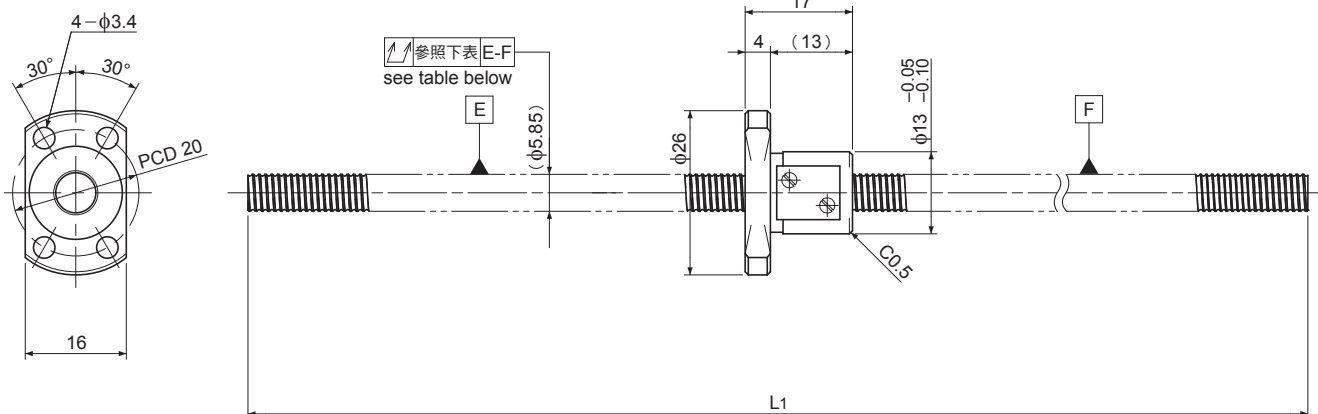

Unit (單位) : mm

Ball Screw Specifications		主要技術參數
Ball size	鋼珠直徑	$\phi 0.8$
Number of thread	螺紋數	1
Thread direction	旋轉方向	Right 右旋
Shaft root dia.	螺桿谷徑	$\phi 5.3$
Number of circuit	循環數	3.7×1
Material 材質	Shaft 螺桿	S55C
	Nut 螺帽	SCM415H
Surface hardness 螺紋部表面硬度		HRC58~ (Thread area)
Anti-rust treatment 防鏽處理		Anti-rust oil 防鏽油

Unit (單位) : mm

Ball Screw Model 滾珠螺桿型號	Travel 行程	Shaft length 螺桿長度	Travel deviation 代表移動量誤差 e_p	Total Run-out 偏擺量 \nearrow	Axial play 軸向間隙	Basic Load Rating 基本額定荷重 N	
		L1				Dynamic 動額定荷重 Ca	Static 靜額定荷重 Coa
PSR0601-200R200C5	175	200	± 0.020	0.050	~ 0.005	680	1200

Note) Please designate end-journal profile with your sketch.

註) 軸端的追加工請提供圖面進行指示。